

User Manual

Outdoor Online UPS

500VA - 3KVA

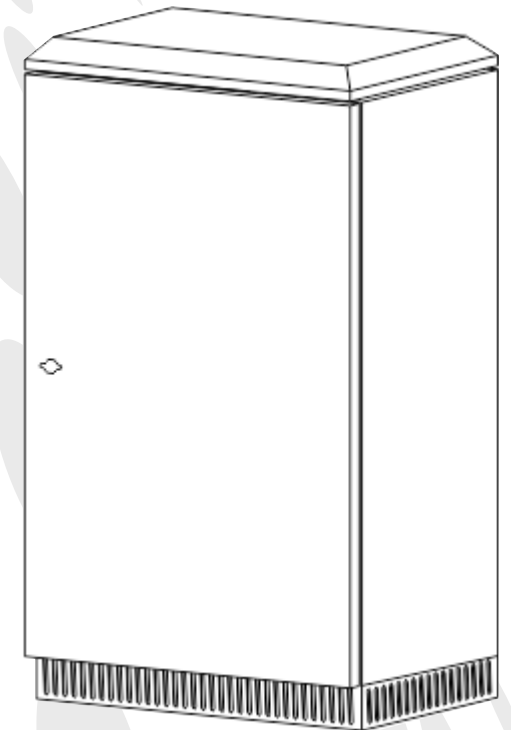

Manual Description

- Thanks for buying our outdoor UPS which is designed for you with trusted safety and reliability and with no need for maintenance. Please read this manual that contains instructions for installation and operation and helps you to achieve the best lifespan and service.
- Please maintain strict compliance with the warnings and operation instructions described in the manual and labeled on the device, and hold the manual in safe keeping. Prior to complete reading of safety and operation instructions, please do not operate the UPS.

Declaration:

- Due to continuous update and improvement of products and technologies, what the manual present may not be completely comply with the real products you receive, and we appreciate your understanding. If you need to query for the latest updates of our products, please contact the local office.

Contents

1 Safety Instructions	1
2 Overview	3
2.1 Introduction.....	3
2.2 Functions and Features.....	3
3 Installation Instructions	5
3.1 Unpack and Inspect.....	5
3.2 Attentions.....	5
3.3 Cable Connection.....	9
3.4 UPS Appearance:	10
3.5 Wiring Diagram for Installation of Battery Pack:	11
4 Operation and Running	13
4.1 Operation.....	13
4.2 Running Mode	14
5 Maintenance and Care	17
6 Panel Indicators Instruction	18
7 Attentions on Battery Handling	20
8 Troubleshooting	21
9 Network Communication	22
10 Communication Interface Instruction	22
Appendix I EMC Classification Standard.....	23
Appendix II Common Symbol Description.....	23
Appendix III Product Properties	24
Appendix IV Communication Interface Ports	26

1 Safety Instructions

CAUTION

- Please keep the battery away from fire to avoid explosion.

CAUTION

The battery may cause electric shock and short circuit, so please observe following precautionary measures when handling the battery:

- Please do not wear wristwatches, rings or other metal objects.
- Use the tool with electrical insulating handle.
- Wear rubber gloves and shoes.
- Please do not put tools or metal objects on the battery.
- Be sure to close the AC input switch before loading and unloading of battery.

CAUTION

- Do not try to open violently or damage the battery. Electrolyte leaked is detrimental to your skin and eyes, and may cause intoxication.
- To replace the battery, using one with the same model is a must.
- Handle gently when replacing the battery, otherwise normal running of the system will be affected.
- To ensure right replacement, you'd better consult our after-sales service representatives.
- The battery contains lead and improper handling will cause harm to the environment and human health. So, please refer to local laws and regulations for handling of waste batteries so as to protect the environment.
- For replacement of battery wire or power cord, please purchase the original replacements from the service stations or dealers of our company, to avoid insufficient capacity that can result in overheating or sparking, and thereby avoid fire.
- Keep the battery away from fire, or it will lead to explosion and injure human.
- Do not touch battery terminals. No isolation between battery circuit and input voltage circuit generates high Voltage between the battery terminals and ground. It may lead to risk of electric shock if you touch them.

Safety in Installation and Use

Caution

- The AC input power of the UPS must be properly grounded.
- High voltage exists inside the UPS, so for safety, to open the enclosure by yourself without guidance is prohibited.
- This system is designed with effective hardware control circuit and software management control program.
- Non-specialized persons are not allowed to dismount or modify the control circuit board by themselves without permission.
- System wiring cannot be changed at will, or the system will run abnormally.
- Exposure to high temperature and sun will overheat the shield panel on the enclosure, so do not touch it with your hands without protection to avoid scalding.

Note

High voltage inside the UPS may cause harm or injury. So for any questions, please consult the professionals in EAST Group Co., Ltd., local service outlets or headquarter customer service center hotline at 800-830-5625, and please do not repair it by yourself without permission.)

2 Overview

2.1 Introduction

- The outdoor type intelligent HF on-line UPS is specially designed for providing uninterruptible AC power for communication equipment, network equipment etc. used in severe outdoor environments such as urban corners, remote suburbs, mountainous areas, and others. With an array of remarkable designs, i.e. resistance to high temperature, severe cold, salt mist, corrosion, dust, water, lightening, to name a few, and a variety of advantages including wide input voltage range, wide input frequency range, and pure, stable and reliable output waveform, this type of UPS has found wide application in outdoor communication base stations in communication, radio and television, aviation and other fields.

2.2 Functions and Features

- The UPS employs 16-bit DSP control and advanced software programming technology that can directly produce HF SPWM wave to control the UPS inverter. This simplifies UPS's control circuit, improves its stability and makes it more practical, thus enabling quick response to the change of outside environment and ensuring higher simplicity and reliability for the whole control circuit.
- Use of digital control technology eliminates the inherent shortcomings of traditional analog control such as hardware parameters, temperature excursion, etc. and thereby ensures consistency and reliability.
- It comes with a power-on self-test (POST) function which enables early detection of potential faults, thus avoiding worse failure and loss.
- Online double-conversion topology design leads to an output of stable pure sine wave power that is free of interference by fluctuations of the mains and therefore provides more comprehensive and perfect protection for the equipment of users.
- As the mains are abnormal or recover to normal, the UPS can realize zero-second switching. This totally meets the high requirements and standards of precision equipment for power supply.
- Default bypass function enables the UPS to switch to the bypass circuit to drive the loads without interruption and provides sound-light alarm when failure occurs.
- Due to advanced voltage compensation technique, the mains input voltage range is up to 110-300V which greatly reduces the use frequency of battery and enhances adaptability of the UPS to harsh power grid environment.

- Due to advanced wide frequency input technique, the input frequency range of the UPS can reach 40-60HZ that makes it compatible with generator and suitable for single phase generators of various types.
- The power input end of the UPS features PFC technology that makes the input power factor above 0.98, improves the mains utilization rate, eliminates harmonic pollution to the mains and reduces cost for running. So, the UPS is an eco-friendly power supply with extremely high cost performance.
- The UPS delivers an unattended operation function. When power failure occurs, it will start battery mode and will automatically power off until low battery voltage. When the mains recover, it will firstly test if the voltage and frequency are in normal range. If they are in normal range, the UPS will automatically power on to drive the loads, and if they are not, the UPS only starts the charger to charge the battery and the loads will not get power until the voltage and frequency of the mains reach normal range.
- Cold start function enables the UPS to power on directly through the battery pack when the mains are not available. This can meet the needs of users for emergency use.
- Error operation prevention function is available. It ensures that each button comes with a delay function and only if the button is pressed for setup time corresponding function can come into operation.
- The UPS comes with superior protection function which enables it to be protected in following situations: over high and low mains voltage, over high and low output voltage, overloading, short circuit, too high temperature of inverter, low battery voltage, battery overcharging, network surge, etc.
- Under battery mode, it allows you to perform switching between silence and alarm of the buzzer through the button on front panel; under the mains mode, manual test can be done.
- The outdoor UPS features an LED screen which can show different working conditions. For example, some common faults codes can be showed on the LED screen and according to fault information code query table, you can quickly check out the fault causes and positions, so that maintenance can be easier.
- Through RS232 serial port plus intelligent monitoring software, the UPS can realize communication with computer and various parameters can be clearly displayed on the communication interface. Therefore, various functions of the UPS can be directly controlled via setting on the computer.
- Owing to an internal or external SNMP card adapter, the UPS can be connected to the internet and offer real time UPS information to the internet. Various network management systems are applicable to carrying out communication and management.

3 Installation Instructions

3.1 Unpack and Inspect

- Open the package of the UPS and inspect attachments including a user manual and a communication cable.
- Inspect if the UPS is damaged in transportation. If the UPS is damaged or lack of components, please do not power it on and inform the carrier and dealer.
- Confirm if the UPS model is right. The model can be checked on the rear panel.

Model	Capacity
0.5KVA	0.5KVA
1KVA	1KVA
2KVA	2KVA
3KVA	3KVA

Note

- **Please keep the packaging box and packaging materials for transportations in the future. This product is too heavy, so please handle gently.**

3.2 Attentions

- The UPS must be placed in well ventilated place and kept away from water, flammable gases and corrosive agents.
- Side lying is inappropriate. It should be placed to keep the air inlet on the lower end of the front panel, the fan outlet on the rear panel and the air inlet on the side smooth.
- Ambient temperature should be kept in $-10^{\circ}\text{C}\sim 45^{\circ}\text{C}$.
- Installation under low temperature may cause water drop condensing that leads to risk of electric shock. So, it cannot be used until it is completely dried.

3.2.1 Protection

- Designed with rain-proof and anti-theft functions, the UPS is ideal for outdoor use.
- After installation or maintenance, please tightly lock the enclosure to ensure reliable seal and theft prevention.

3.2.2 Handling

The outermost layer of the UPS is a sun protection cover that cannot be used to bear the stress in handling.

To ensure safety, you need pay attentions to:

- In transportation or handling, battery, battery wires and other cables are placed separately.
- To avoid acute shock and impact and handle gently.
- To avoid placing upside down.

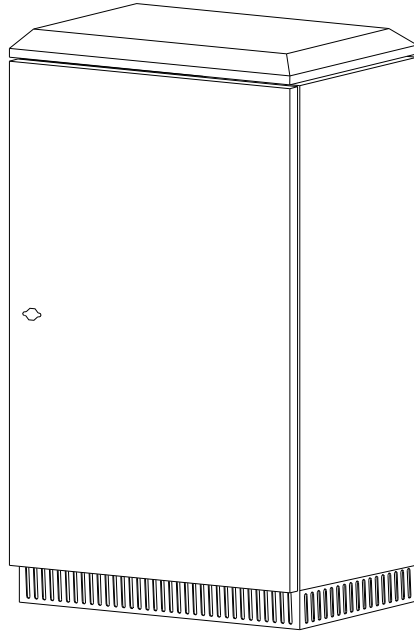

System Appearance Diagram

3.2.3 System Introduction

- The UPS system for outdoor communication equipment is one of the state of the art UPS systems in the world and comes with high usability. When developing new system, we design specialized UPS power module and physical construction to withstand harsh environment and meet the characteristics of electrical equipment. This can enormously improve the adaptability of UPS system which can run safely and reliably all year round in various environments. In addition, we add dry contact output function to the system, which enables the user to timely know the running status, so as to find problems in time and perform timely troubleshooting.
- This UPS system comprises: Cooling fan, AC C-Class lightning protection module, UPS (rack type), battery, control switch, terminals, outlets, etc.

A) System Installation

Before moving the UPS out of the wooden box, you should see if the box is damaged and check if there are dents or other damages on the product. If there are any damages, please immediately contact the carrier.

B) Unpack

The system comes with primary and secondary packages, so there are a number of boxes. The device is easily damaged when taking out of the box, so please be cautious and carry out unpacking and installing according to the guide.

C) Installation

- Tools for installations include:
- Cross-head screwdriver, wire stripper, slotted screwdriver and wrenches (shaft sizes: 10 and 13)
- Take out the whole system, open front and rear panels and unscrew the M8 screws at 4 corners of the rack bottom to remove the base.

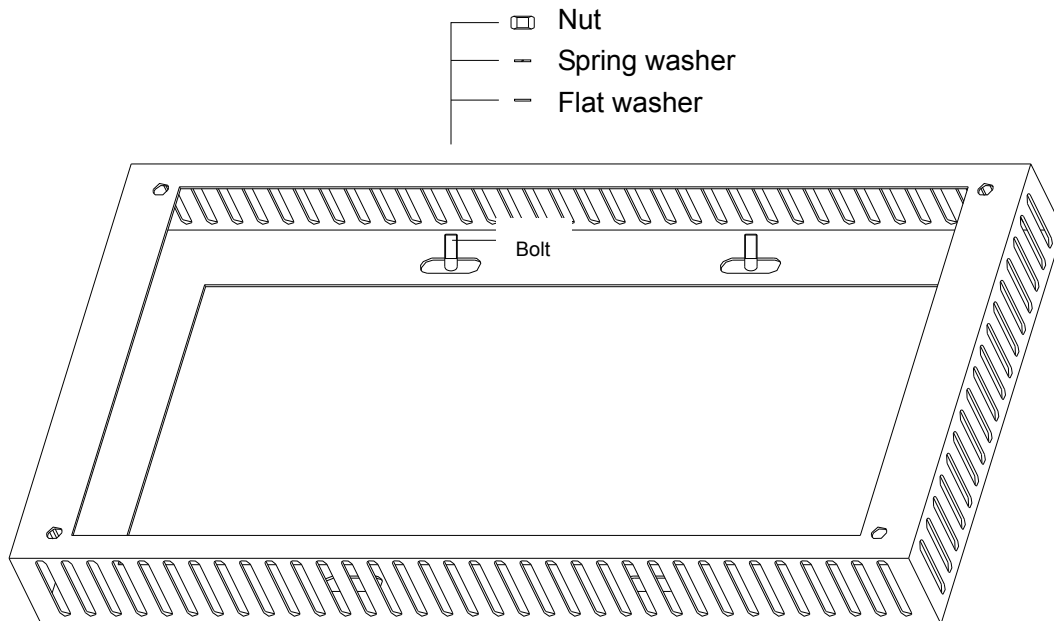

Figure 1 Base Fixing Diagram

- Please fixed the base on to the installation platform according to the dimensions shown in above diagram.

This UPS system offers two groups of installation holes, as shown above. A group is a 51*12 elliptical hole and B group is a round hole with a diameter of 12.

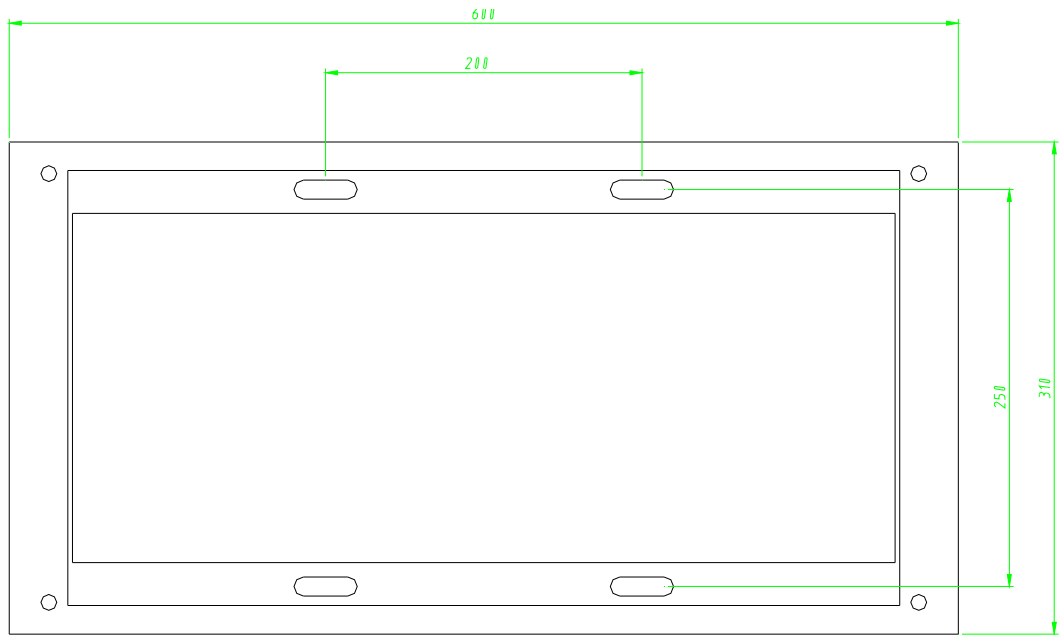

Figure 2 Base Installation Dimension (1KVA)

There are two specific installation methods, as described below:

- a) Concrete Platform Installation: When the UPS is required to be installed on concrete platform, firstly pre-install four M10 anchor screws on the concrete platform according to the dimensions of A or B group installation holes shown in Figure 3, and then fix the base to the platform using M10 screws, flat washer and spring washer shown in Figure 3. After that, place the UPS rack on the fixed base and open the front and rear panel to fix it to the base again using the 4 M8 screws removed in the second step, as shown below.

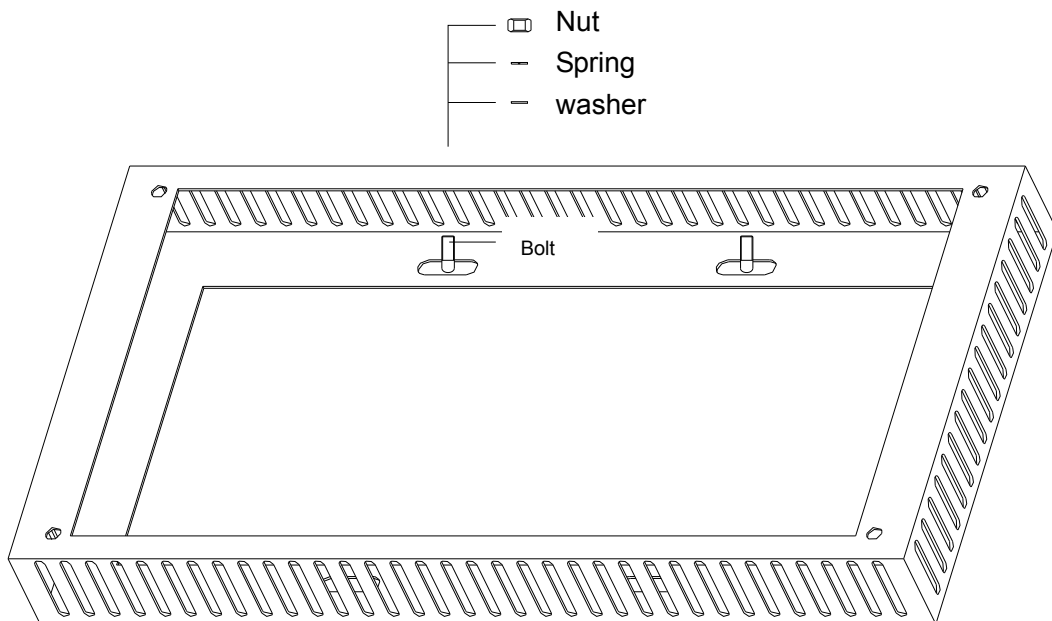

Figure 3 Installation Diagram

b) Iron Stand Platform Installation: When the UPS is required to be installed on an iron stand platform, firstly fix the base on the iron stand platform according to the dimensions of A group installation holes shown in Figure 4 using 4 U-shaped clamps, gasket, flat washers, spring washers and nuts (as shown in Figure 4). After doing this, place the UPS rack on the fixed base and open the front and rear panel to fix it to the base again using the 4 M8 screws removed in the second step, as shown below.

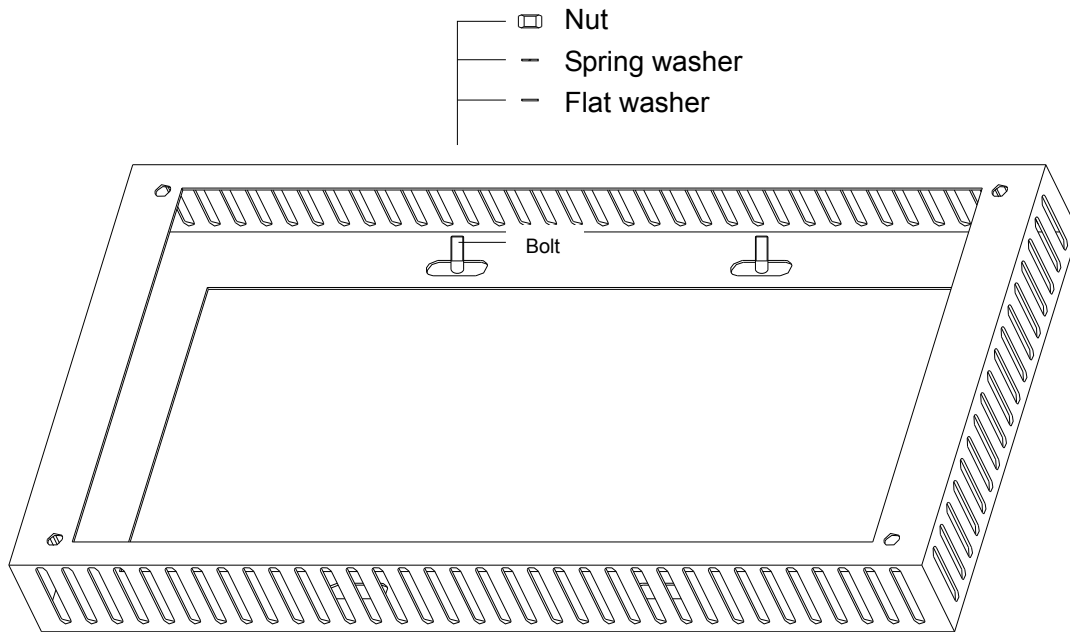

Figure 4

3.3 Cable Connection

Mains input			Output 1		Output 2		Ground
Ground	L	N	N	L	N	L	

Figure 5 Cable Connection Diagram

Note:

- When connecting loads to the UPS, you have to firstly power off the loads, then conduct cable connection and finally power on the loads one by one.
- Used power socket should be grounded.
- When it is required to connect motor, display, laser printer and other inductive loads, due to too high initial power, the UPS selected has to come with a capacity that is determined by the initial power. Generally, the initial power is twice as high as the rated power.

3.4 UPS Appearance:

A) External View



External View of the Front

B) Internal Structure



Internal Structure

3.5 Wiring Diagram for Installation of Battery Pack:

- First: use the battery wires attached in the box to connect the batteries in series;
- Second: Connect the red wire to the positive pole and the black wire to the negative pole.
- If you want to replace or repair the battery, please disconnect the battery terminals and then dismantle the wires respectively.

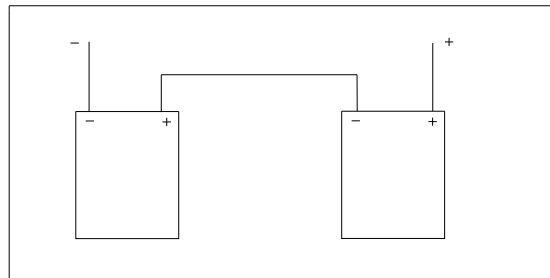

0.5K/1KVA Battery Pack Installation Diagram

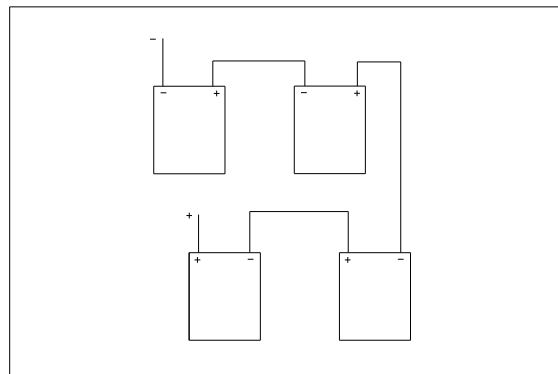

2KVA Battery Pack Installation Diagram

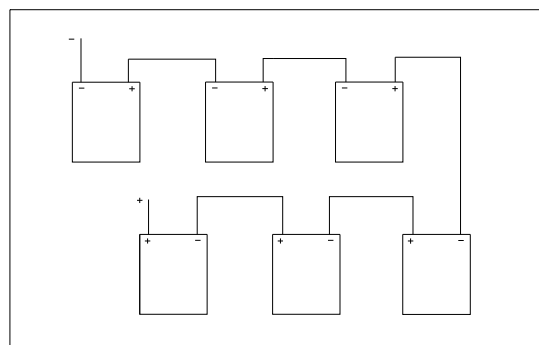

3KVA Battery Pack Installation Diagram

UPS Function Module:

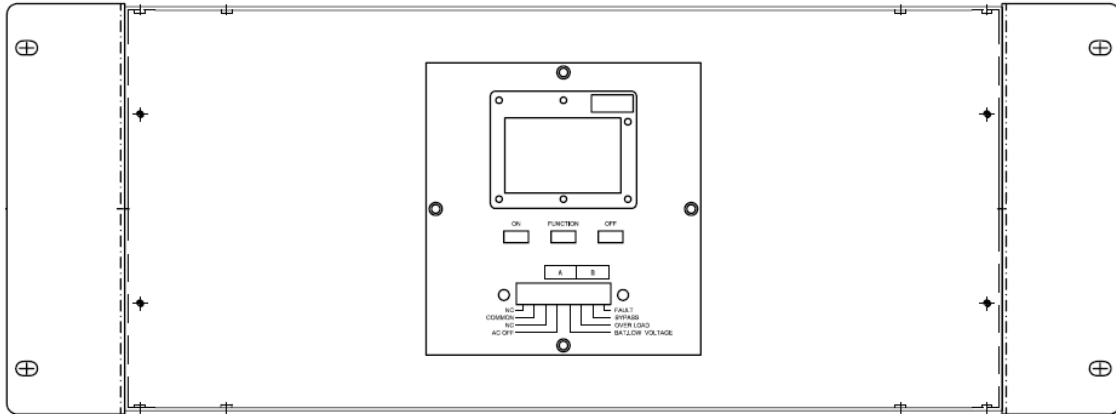

UPS Main Unit Module

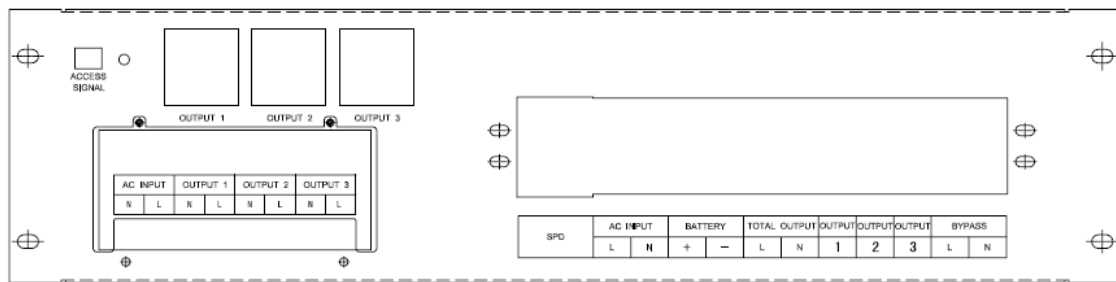

Power Distribution Module

Note:

The outdoor intelligent HF series UPS has to rely on rated battery voltage to realize normal start.

4 Operation and Running

The UPS provides ease of operation. After reading this manual, the operators without receiving any special training can operate it only according to the guidance in the manual.

4.1 Operation

- **Connect to the mains and power the UPS on**

- Connect the UPS to the mains. Specified software can be used to set the UPS whether it needs to work under bypass mode.
- Press the power on button for more than 2 seconds to start the UPS.
- The UPS will firstly conduct self-test after power on, during which the battery indicator and capacity indicator on the panel light up (press the function buttons for more than half second and less than 2 seconds to switch to loads indicator), and status lights go out one by one from right to left and then light up one by one from left to right. After a few seconds, inverter indicator and load indicator light up (the capacity indicator can light up correspondingly according to the capacity of load). This indicates that the UPS has been under the mains mode. If the mains are abnormal, the UPS will work under battery mode.

- **UPS power on (DC) without connection to the mains**

- Without connection to the mains, press the power on button for more than 2 seconds to start up the UPS.
- This UPS power-on process is similar with that of connection to the mains. After a few seconds, the inverter indicator and battery status indicator on the panel light up, and the alarm indicator blinks and makes a sound every 4s. Meanwhile, the battery capacity indicator also lights up and the number of capacity indicators that light up indicates the current battery capacity.

- **UPS power off as connected to the mains**

- Press the power off button for more than 2 seconds.
- If the UPS is set to work under bypass mode, the bypass indicator will light up.
- After power off, the UPS still has output and the load indicator still on. To ensure no output, you only need to disconnect the power cord from the mains. Then, the panel shows nothing and the UPS has no output voltage.

- **UPS power off (DC) without connection to the mains**

- Press the power off button for more than 2 seconds.
- The status indicators on the panel go out in turns from right to left and lights up in turns from left to right. This will last until the there is nothing shown on the panel and the UPS has no output voltage.

4.2 Running Mode

- **Utility Mode**

- When the UPS runs under utility mode, the panel indicates status as shown in following figure. The inverter indicator and load indicator will light up and the capacity indicator will light up according to the load capacities.
- If the inverter indicator blinks, it indicates that the neutral and live wires are inversely connected or the mains are abnormal; if the inverter indicator and battery indicator stably light up, it indicates the UPS is running under battery mode.

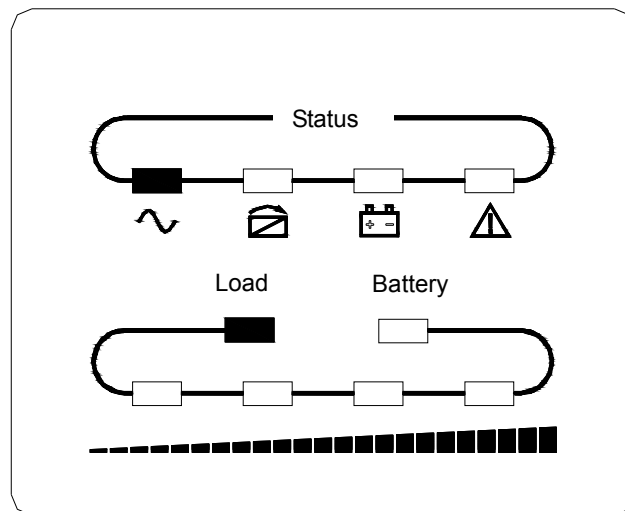

UPS Runs under Utility Mode

- If the load indicator lights up more than 100%, the buzzer will beep twice per second and the capacity indicator and alarm indicator will blink to remind you to remove unnecessary loads until the load capacity is less than 100%.
- If the battery indicator blinks, it indicates that the battery is not connected or the battery voltage is too low. You should check whether the battery is connected or not and press power on button for 2 seconds to conduct battery test. If the battery is indeed connected, the problem may be caused by battery fault or aging. Refer to the abnormal condition handling table in the chapter 6 to solve this problem.

Attention:

If connected to a generator, the UPS has to be operated according to following steps:

- Start the generator and after it runs stably, connect its output end to the input end of the UPS (the UPS runs without loads at this time), and then press the power on button. After the power on, connect loads one by one.
- We suggest that capacity of the generator should be twice as high as the capacity of UPS.

- **Battery Mode**

When the UPS runs under battery mode, the panel indicates status as shown in the following figure. The battery indicator and inverter indicator light up. Battery capacity indicator will light up according to the battery capacity (the panel shows the battery capacity is 100%. Note that the load indicator under utility mode will serve as the battery capacity indicator in backup time) and alarm indicator will blink.

- When the UPS runs under battery mode, the buzzer beeps once every 4 seconds. If you press the function button for more than 2 seconds at this time, the UPS will carry out silence function and the buzzer will not beep and press again for more than 2 seconds, alarm recovers.
- When the battery capacity reduces, the number of battery indicators that lights up will reduce and when the battery voltage reduces to alarm level, the buzzer beeps once per second, reminding the user that the battery capacity is insufficient and the loads should be closed one by one immediately.
- Under battery mode, back-up function can be tested.

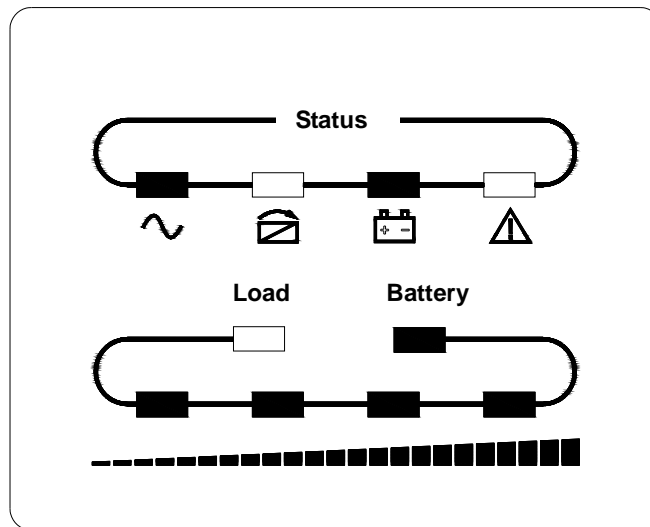

UPS Runs under Battery Mode

- **Bypass Mode**

The panel shows a status in the following figure when the UPS runs under bypass mode. The bypass indicator lights up, alarm indicator blinks and load indicators will light up correspondingly depending on the capacity of connected loads. In addition, the buzzer beeps once per two minutes and stops sounding after power on.

- If the inverter indicator blinks, it indicates the voltage or frequency of the mains has exceeded normal range or the neutral and live wires are connected inversely.

- Other indications on the panel are same with the utility mode.
- When the UPS runs under bypass mode, it has no back-up function. At this time, the UPS directly supplies filtered utility power to the loads.

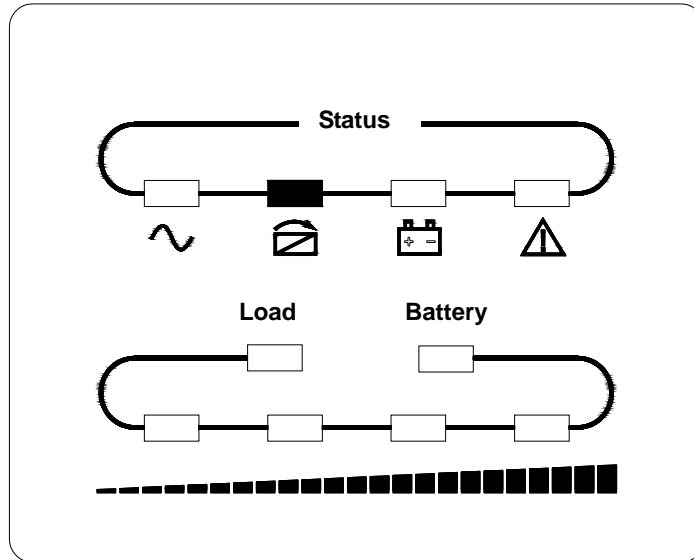

UPS Runs under Bypass Mode

- **Abnormal Mode**

- If the fault indicator lights up during running of the UPS, it indicates the UPS is running under an abnormal mode. Refer to the abnormal condition handling table in the chapter 6 to solve this problem.

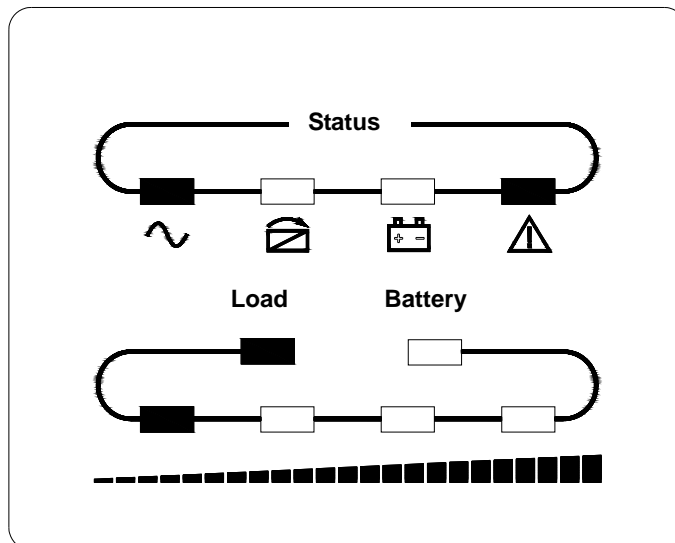

UPS Runs under Abnormal Mode

5 Maintenance and Care

- This series of UPS features low maintenance. The battery in a standard type UPS is adjusted through valve and offers low maintenance. All that is needed to achieve expected service life of the battery is to maintain charging. When the UPS is connected to the mains, in spite of power on or off, it charges the battery all the time and provides overcharge and over-discharge protection.
- If the UPS is not used for a long time, it is suggested to charge the battery once every 4 to 6 months.
- Normally, service life of the battery is 3 to 5 years. Early replacement is a must if you find the battery performs poorly. Battery replacement must be carried out by specialized persons.
- It is inappropriate to replace individual battery in the battery pack. When replacing the whole battery pack, please follow the instructions of battery supplier.
- Under normal condition, the battery should be charged and discharged once every 4 to 6 months. Discharge until the UPS is powered off and then charge again. Standard charging time is at least 12 hours.
- In high temperature zone, the battery should be charged and discharged once every 2 months. Standard charging time is at least 12 hours.

Attention:

- The UPS must be turned off and deenergized from the mains prior to replacement of battery.
- Take off rings, wristwatches, and many other metal object you are wearing on your hand.
- Use the screwdriver with insulating handle and do not put tools or other metal objects on the battery.
- Slight spark generated at the connector when connecting battery wires is normal. It will not result in harm to human and the UPS.
- It is prohibited to short-circuit or improperly connect the positive and negative poles of the battery.

6 Panel Indicators Instruction

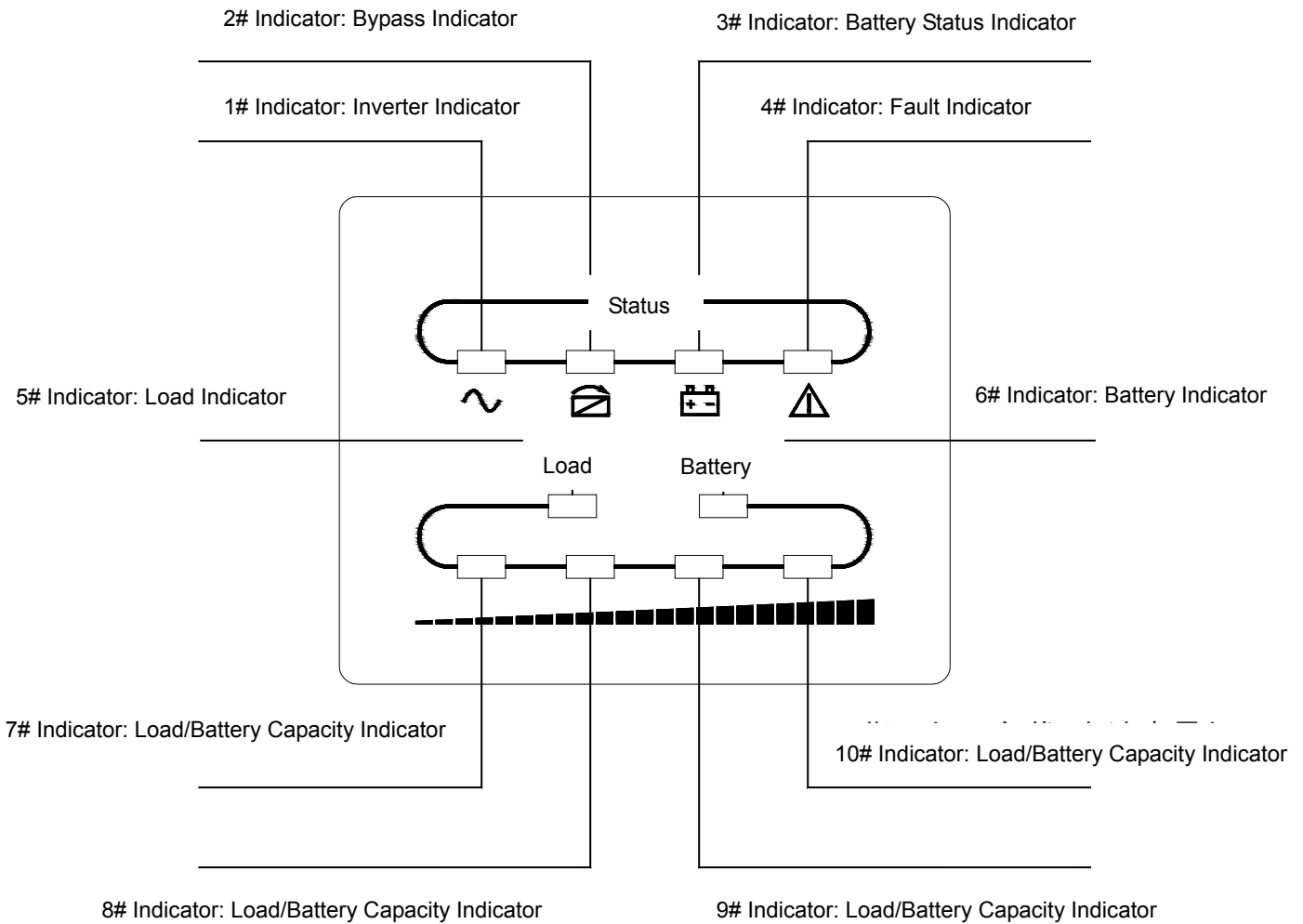

Panel Indicator and Working Status Correspondence Table

Indicator Status in Faults:

Faults type	Capacity indicator 1	Capacity indicator 2	Capacity indicator 3	Capacity indicator 4
Output short circuit	•	•	•	•
Over temperature	•	•	•	
Overload	•	•		
Bus voltage fault			•	•
Inverter voltage fault	•			
Input NTC fault		•		
Cold start fault			•	
Power off fault				•

No.	Working status	Panel indicator status				Alarm beep	Remarks
		Normal	Bypass	Battery	Fault		
1	Utility Mode						
	Normal voltage of utility power supply	●				None	
	Normal voltage of the utility power supply	★				None	Inverse connection of neutral wire
	High/low voltage protection, switch to battery mode	●		●	★	Beep once every 4 seconds	
2	Battery mode						
	Normal battery voltage	●		●	★	Beep once every 4 seconds	
	Abnormal battery voltage and alarm	●		★	★	Beep once per second	
3	Bypass mode						
	Normal voltage of utility power supply (under bypass)		●		★	Beep once every 2 minutes	Disappear after power on
	High voltage alarm of utility power supply (under bypass)				★	Beep once every 4 seconds	
	Low voltage alarm of utility power supply (under bypass)				★	Beep once every 4 seconds	
4	Battery disconnection alarm						
	Under bypass condition		●		★	Beep once every 4 seconds	Please confirm whether the battery switch is closed or not
	Under inverter condition	●			★	Beep once every 4 seconds	Please confirm whether the battery switch is closed or not
	Power on or start up					Beep 6 times	Please confirm whether the battery is properly connected
5	Output overload protection						
	Overload under utility mode, in alarming	●			★	2 beeps per second	Remove the loads of low importance
	Overload under utility		●		●	Long beep	Remove the loads of

	mode, with protection action						low importance
	Overload under battery mode, in alarming	●		●	★	2 beeps per second	Remove the loads of low importance
	Overload under battery mode, with protection action	●		●	●	Long beep	Remove the loads of low importance
6	Bypass overload alarm		●		★	Beep once every 2 seconds	Remove the loads of low importance
7	Fan abnormal	▲	▲	▲	★	Beep once every 2 seconds	Please check whether the fan gets stuck by objects

● _ Indicator is in steady light

★ _ Indicator blinks

▲ _ Indicator status depends on other conditions

Offer following information when you contact the maintenance personnel:

- UPS Model No. and Serial No.
- Problem occurrence date
- Complete description about the problem (including panel indicator status, sound, utility power condition, load capacity, and battery configuration situation if it is a long-acting UPS)

7 Attentions on Battery Handling

- Prior to handling, take off your rings, wristwatches and similar metal object.
- When replacing battery wires, please purchase the original replacements from our service stations or dealers, so as to avoid insufficient capacity that can result in overheating or sparking, and thereby avoid fire.
- Keep the battery or battery pack away from fire, or it will lead to explosion and injure human.
- Do not try to open violently or damage the battery. Electrolyte leaked is detrimental to your skin and eyes, and may cause intoxication.
- To avoid short circuit between positive and negative poles of the battery, otherwise causing fire or electric shock.
- Before touching the battery, please check if there is voltage. No isolation between battery circuit and input voltage circuit generates high voltage between the battery terminals and ground, which will cause risk of electric shock.
- Refer to the Chapter Four to conduct Maintenance and Care for the battery.

8 Troubleshooting

Abnormal Conditions Handling Table

Faults	Causes	Solutions
#3, 4 indicators and fault indicator are in steady on state, and buzzer in long beep state.	Bus voltage fault	Measure the bus voltage and see if it is normal, or please contact your supplier.
#4 indicator and fault indicator are in steady on state, and buzzer in long beep state.	Soft start fault	Find the power on soft start part and check if the soft start resistance is damaged or please contact your supplier.
#1 indicator and fault indicator are in steady on state, and buzzer in long beep state.	Inverter voltage fault	Please contact your supplier.
#1, 2 and 3 indicators and fault indicator are in steady on state, and buzzer in long beep state.	Over temperature inside the UPS	Confirm that the UPS is not overloaded and air outlet is not blocked. Wait for 10 minutes to cool the UPS and restart it. If the problem stills exists, please contact your supplier.
#1, 2, 3 and 4 indicators and fault indicator are in steady on state, and buzzer in long beep state.	Output short circuit	Turn off the UPS and remove all loads. Confirm the loads have no faults or inside short circuit. Restart the UPS. If the problem stills exists, please contact your supplier.
#1 and 2 indicators and fault indicator are in steady on state, and buzzer in long beep state.	Overload	Inspect the load capacity and remove unnecessary loads. Recalculate the power of loads and reduce the number of loads connected to the UPS and then inspect if the loads have faults.
#2 indicator and fault indicator are in steady on state, and buzzer in long beep state.	Input NTC fault	Please contact your supplier.
#3 indicator and fault indicator are in steady on state	Soft start fault	Find the BUS soft start part and check if the BUS soft start is normal. If it is abnormal, please contact your supplier.
#4 indicator and fault indicator are in steady on state	Power off fault	Test if the power off button is normal and if the SD signal is normal. If they are abnormal, please contact your supplier.

Fault indicator is in steady on state and buzzer beeps once every 2 seconds	Fan fault	Inspect if the fan is properly connected, if the fan is locked or if the fan is damage. If above conditions are all normal, please contact your supplier.
After the power-on button is pressed, the UPS fails to start up	Too short press on the power-on	Press the power-on button for more than 2 seconds and start up the UPS.
	UPS input end is not properly connected or is the battery not connected	Properly connect the UPS to the utility power supply. For a standard UPS and the battery voltage is low, please firstly power off and then power on without loads.
	Internal fault	Please contact your supplier.
Short battery discharge time	Insufficient charge	Keep the UPS connected to the utility power supply for more than 3 hours to recharge the battery.
	UPS overload	Inspect load capacity and remove unnecessary equipment.

9 Network Communication

The outdoor UPS provides a network interface (Intelligent) which allows for matching with a specialized Ethernet card to realize network communication. For specific information, please contact the dealer or customer service center.

10 Communication Interface Instruction

The UPS delivers analogue relay contact and RS232 serial port to carry out communication with the computer. The analogue relay contact utilizes “ON” and “OFF” states of the transistor to transmit input power and UPS status to the host computer. RS232 serial port provides serial communication interface to monitor the information of input power and UPS, and control working status of the UPS.

Note:

Connection to the communication interface needs to use the special cable attached in the package.

RS232 Serial Port Setting:

- ◇ Rate: 2400bps
- ◇ Bit length: 8bit
- ◇ Epilog code: 1bit
- ◇ Parity Bit: None













Appendix I EMC Classification Standard

According to following EMC classification standard:

0. 5KVA-3KVA	
EMS	
IEC61000-4-2(ESD)	Level 4
IEC61000-4-3(RS)	Level 3
IEC61000-4-4(EFT)	Level 4
IEC61000-4-5(Surge)	Level4
EMI	
GB9254-1998/IEC62040-2	Class B

Appendix II Common Symbol Description

Following symbols are used in this manual and may also be found during application of the UPS. So, please be familiar with them and know their meanings.

Symbol and Meaning			
Symbol	Meaning	Symbol	Meaning
	Caution		Protective grounding
	Danger! High voltage		Alarm removed
ON	Turn on the UPS		Overload
OFF	Turn off the UPS		Battery test
	Standby or Power off		Recirculation
	AC		Circulation button on the display
	DC		Battery

Appendix III Product Properties

Electrical Properties

UPS Models	0.5KVA	1KVA	2KVA	3KVA
Load standard	500VA/400W	1000VA/800W	2000VA/1600W	3000VA/2400W
Standard voltage	220VAC			
Standard frequency	50Hz/60Hz			

Input

UPS Models	0.5KVA	1KVA	2KVA	3KVA
Voltage(single-phase) range	110~300VAC (Half load) 140~300VAC (Full load)			
Rated input frequency	50Hz/60Hz Self adaption			
Frequency range	46Hz~54Hz (40-60HZ settable)			
Power factor	≥0.98			

Output

UPS Models	0.5KVA	1KVA	2KVA	3KVA
Voltage error	220×(1±2%)VAC			
Frequency range	Same as the input frequency (under utility mode) 50±0.2Hz (under battery mode)			
Overload capacity	When the load rate is at 108%-125%, the UPS can work for 10 minutes and then switches to bypass and at the same time alarms.			
	When the load rate is at 125%~150%, the UPS can work for 30s and then switches to bypass and at the same time alarms.			
	When the load rate is at 150%~200%, the UPS can work for 200ms and then switches to bypass and at the same time alarms.			
	When the load rate is more than 200%, the UPS can work for 0ms.			
Load crest	3:1			
Output power factor	0.8			

Battery Voltage

UPS Models	0.5KVA	1KVA	2KVA	3KVA
Battery nominal voltage	24VDC	24VDC	48VDC	72VDC

Battery Configuration

UPS Models	Battery Configurations
0.5KVA/1KVA	2 pieces of 50AH-100AH battery can be installed inside the UPS
2KVA	4 pieces of 50AH-100AH battery can be installed inside the UPS
3KVA	6 pieces of 50AH-100AH battery can be installed inside the UPS

Note: Backup time of long-acting UPS differs in the capacities of external batteries.

Switching Time

UPS Models	0.5KVA	1KVA	2KVA	3KVA
Switch from utility mode to bypass mode	≤4ms			
Switch from utility mode to battery mode	0ms			

Working Environment

UPS Models	0.5KVA	1KVA	2KVA	3KVA
Temperature	-10°C~45°C			
Humidity	0~95% without water drops			
Altitude	≤1500 m. Derating for above 1500 m			
Storage temperature	-45°C~70°C			
IP Rating	IP55			

Overall Efficiency

Full load under utility mode	≥90%
Full load under battery mode	≥87%
ECO mode	≥94%

Mechanical Properties

UPS Models	0.5KVA	1KVA	2KVA	3KVA
Size W×D×H(mm)	660(W) ×332(D) ×965mm(H)		600(W) ×432(D) ×1045mm(H)	600(W) ×432(D) ×1045mm(H)
Weight (KG)	60KG(Battery not included)		80KG(Battery not included)	82KG(Battery not included)
	70KG		90 KG	92 KG

Appendix IV Communication Interface Ports

- Computer Port**

The outdoor intelligent UPS is designed with a standard DB9 port on the front panel. This port offers several signals which are distributed as follows:

Pins	Distribution	Pins	Distribution
1	NC	6	NC
2	Transmit	7	NC
3	Receive	8	NC
4	NC	9	Awaken
5	GND		

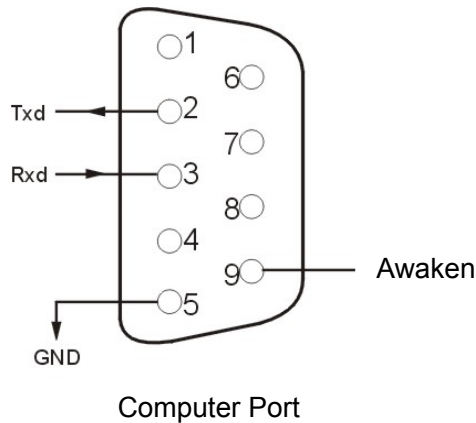

- Dry Contact Interface**

As long as a dry contact interface card (optional) is installed, the UPS monitoring function from the card can be used to monitor the power supply.

Dry contact alarm employs a relay output mode.

Alarm functions: UPS fault, utility fault, low battery voltage

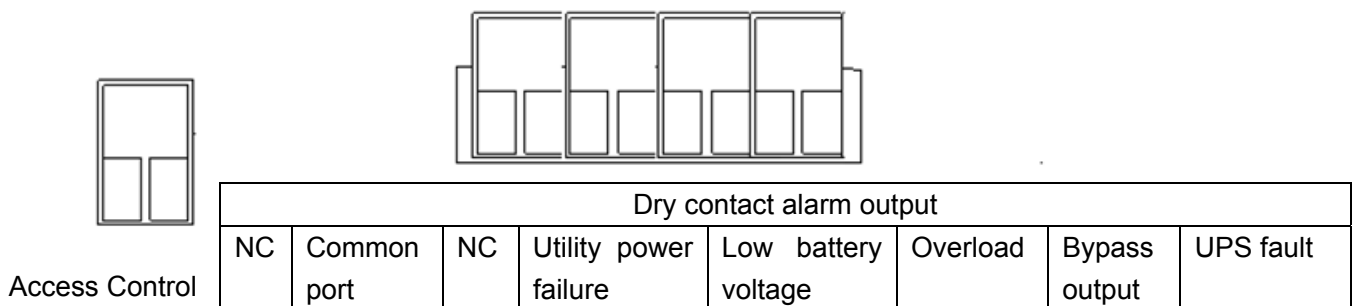

UPS dry Contact Alarm Output Parameters Definition:

- **UPS fault alarm:**

UPS fault alarm will happen as the UPS gets into such problems as over high and over low voltage of utility power supply, over high and over low output voltage, overload, short circuit, inverter over temperature, low battery voltage, battery overcharge and internal hardware fault.

- **Utility power failure:**

When load <70% and voltage of the mains $\leq 110\pm 5V$ or $\geq 300\pm 5V$, the utility power supply is abnormal;

When load $\geq 70\%$ and voltage of the mains $\leq 140\pm 5V$ or $\geq 300\pm 5V$, the utility power supply is abnormal;

When input frequency $\leq 46\text{HZ}$ or $\geq 54\text{HZ}$, the utility power supply is abnormal.

- **Low battery voltage alarm:**

When the battery discharge voltage $\leq 10.5\text{VDC}$ (single battery), low battery voltage alarm happens.

- **Access control alarm:**

When the door is opened, the access control alarm beeps.

Remarks:

Alarm output employs a relay output mode. To be specific, when a fault is alarmed, it will be short circuited between corresponding alarm point and public point, and when the fault is removed, the circuit between corresponding alarm point and public point will open.

- **Network Communication**

The outdoor UPS provides an intelligent slot for an intelligent Ethernet card. Compatible with popular software and hardware and network operating system on current internet, specialized Ethernet card can run HP openview, IBM netview and SUN netmanager operating systems. The UPS feature a direct networking function which provides real time UPS information and power supply information, and carry out communication and management through various network management systems.

For specific information, please contact local agents.